

## Technical Specifications

### Absolute Maximum Ratings

DC input voltage	18 V (relative to DUT ground)
DC output current	(Pin 1) +50 mA
Voltage on I/O pin	0 V to 6 V (when configured as input or powered down) (relative to local ground)
Voltage on I/O pin	0 V to $V_{IO} + 0.3$ V (when configured as output) (relative to local ground)
Temperature Range	+5 °C to +45 °C (operational)
Humidity	< 95% (non-condensing)

### Recommended Operating Conditions

DC input voltage	5 V to 15 V (7 V to 15 V for 5 V I/O voltage option) (relative to DUT ground)
Voltage on I/O pin	0 V to $V_{IO}$ (relative to local ground)
Maximum working isolation voltage:	443 $V_{RMS}$

### JTAG Connector Pinouts

#### XJLink Connector (P1)

$V_{IO}$ (input)	1	2	XJLink ground
Output	3	4	XJLink ground
Input	5	6	XJLink ground
Input	7	8	XJLink ground
Input	9	10	XJLink ground
Input	11	12	XJLink ground
Output	13	14	XJLink ground
Input	15	16	XJLink ground
Input	17	18	XJLink ground
NC	19	20	XJLink ground

#### DUT Connector (P2)

$V_{IO}$ (output)	1	2	DUT ground
Input	3	4	DUT ground
Output	5	6	DUT ground
Output	7	8	DUT ground
Output	9	10	DUT ground
Output	11	12	DUT ground
Input	13	14	DUT ground
Output	15	16	DUT ground
Output	17	18	DUT ground
NC	19	20	DUT ground

### DC Electrical Characteristics

Over recommended operating free-air temperature range  
 Output voltage set by XJLink. Variable from 1.8 V to 3.3 V (configurable extension to 5 V)  
 Output voltage tolerance:  $\pm 3\%$  (plus tolerance of XJLink)

I/O Voltage	$V_{IL}$ Max	$V_{IH}$ Min	$V_{OL}$ Max	$V_{OH}$ Min	Load conditions
5.0	0.8	3.5	0.4	4.6	$\pm 4$ mA
3.3	0.8	2.35	0.4	2.9	$\pm 4$ mA
2.5	0.8	1.75	0.4	2.1	$\pm 4$ mA
1.8	0.6	1.3	0.4	1.4	$\pm 4$ mA

### Physical Dimensions

Size: 64 mm x 53.5 mm x 14 mm (including connectors)

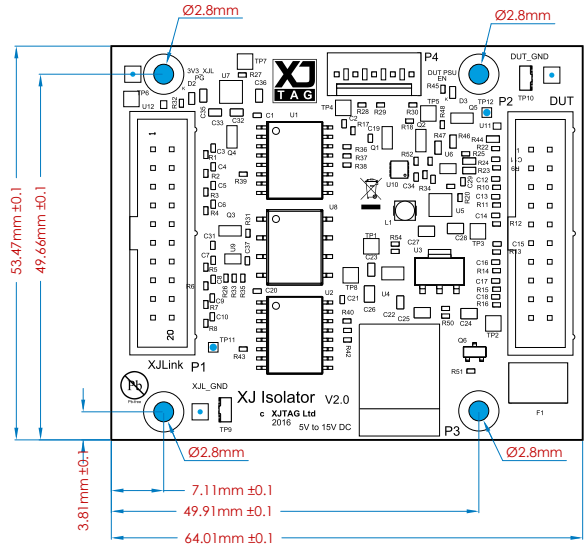

### TCK Frequency

All supported XJLink TCK frequencies up to 50 MHz.  
 Autoskew compensates for the delay introduced by the cable and the JTAG devices by up to 3 TCK periods.

### Power Supply

Maximum supply current: 150 mA  
 Power supply plug should have 2.1 mm inner diameter and 5.5 mm outer diameter. The pin is positive and the outer DUT ground.  
 Example supplier parts codes for power supply plug:  
 Digikey CP3-1000-ND, Farnell 224923.

### JTAG Connector

Standard 0.1" pitch 20-way connector. Example supplier parts codes for mating plug IDC plug (20-way ribbon cable will be required):  
 Digikey 2-215882-0-ND, Farnell 1200505, RS 426-3839.

### Visual Indication

- LED1: Internal supply voltage enabled
- LED2: DUT I/Os enabled

### Configuration

Component	$V_{IO}$ range 1.8 V to 3.3 V (default)	Extended $V_{IO}$ range to 5 V
R23	0R	NF
R24	NF	0R
R46	NF	20k (1%)
R47	0R	10k (1%)

The XJLink bank voltage should be set to 3.3 V when the XJIsolator board is configured for 5 V I/O.